

PD.1 (D1)  
 PD.5 (D5)  
 PD.0 (D0)

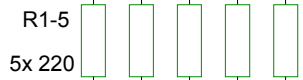

PD.4 (D4)  
 PD.3 (D3)  
 PD.7 (D7)  
 PD.2 (D2)  
 PD.6 (D6)

Note: Pinnumbers in parentheses are for Arduinos

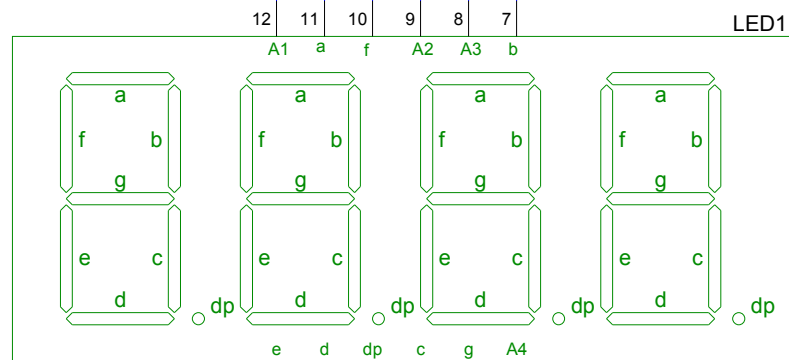
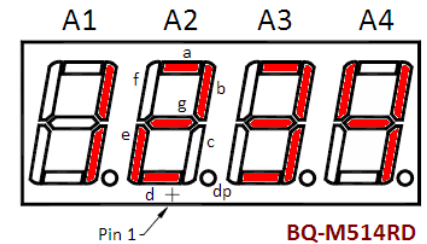
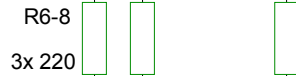
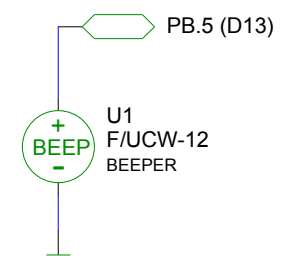
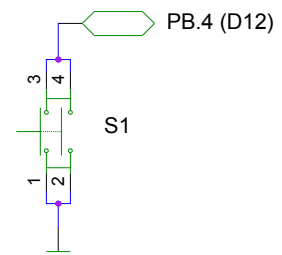
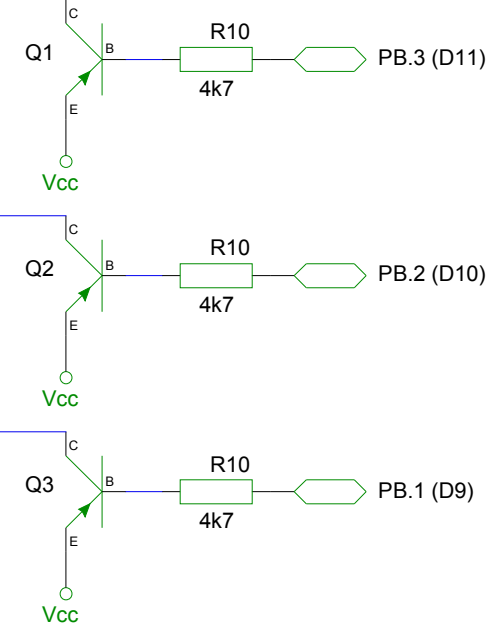

### 7-segment LED display shield for Arduino

TITLE			REVISION:	30. 11. 2011
FILE:	4x7segArduinoShield.sch		DRAWN BY:	Richard Balogh
PAGE	1	OF	1	